



## 600V/4A N-Channel Advanced Power MOSFET

### Features

- Maximum Junction Temperature Range (150°C)
- 100% Avalanche Tested

BVDSS	600	V
ID	4	A
RDSON@VGS=10V	2.3	Ω

### Applications

- Power factor correction (PFC)
- Switched mode power supplies(SMPS)
- Uninterruptible Power Supply (UPS)

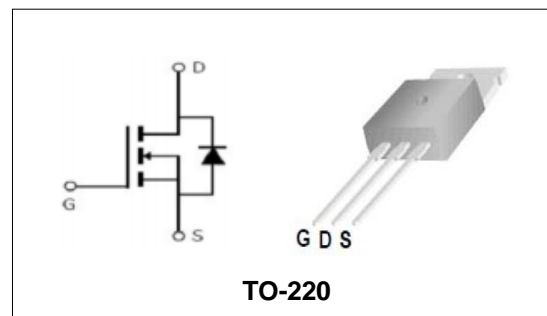

### Order Information

Product	Package	Marking	Tube	Carton
PTP4N60	TO-220	PTP4N60	50PCS	5000PCS

### Absolute Maximum Ratings

Symbol	Parameter	Rating	Unit	
<b>Common Ratings (TC=25°C Unless Otherwise Noted)</b>				
$V_{(BR)DSS}$	Drain-Source Breakdown Voltage	600	V	
$V_{GS}$	Gate-Source Voltage	±30	V	
$T_J$	Maximum Junction Temperature	150	°C	
$T_{STG}$	Storage Temperature Range	-55 to 150	°C	
$I_S$	Diode Continuous Forward Current	TC =25°C	4	A
<b>Mounted on Large Heat Sink</b>				
$E_{AS}$	Single Pulse Avalanche Energy (Note1)	200	mJ	
$I_{DM}$	Pulse Drain Current Tested (Silicon Limit) (Note2)	TC =25°C	16	A
$I_D$	Continuous Drain current	TC =25°C	4	A
$P_D$	Maximum Power Dissipation	TC =25°C	109	W
$R_{θJC}$	Thermal Resistance Junction-to-Case (Note3)	1.15	°C/W	
$R_{θJA}$	Thermal Resistance Junction-to-Ambient (Note3)	65	°C/W	

**600V/4A N-Channel Advanced Power MOSFET**

Symbol	Parameter	Condition	Min.	Typ.	Max.	Unit
<b>Static Electrical Characteristics @ T<sub>J</sub> = 25°C (unless otherwise stated)</b>						
V <sub>(BR)DSS</sub>	Drain- Source Breakdown Voltage	VGS=0V ID=250μA	600	--	--	V
I <sub>DSS</sub>	Zero Gate Voltage Drain current	VDS=600V,VGS=0V	--	--	1	μA
I <sub>GSS</sub>	Gate-Body Leakage Current	VGS=±30V,VDS=0V	--	--	±100	nA
V <sub>GS(TH)</sub>	Gate Threshold Voltage	VDS=VGS,ID=250μA	2	3	4	V
R <sub>DS(ON)</sub>	Drain-Source On-State Resistance (Note4)	VGS=10V, ID=2A	--	2.3	2.5	Ω
<b>Dynamic Electrical Characteristics @ T<sub>J</sub> = 25°C (unless otherwise stated) (Note5)</b>						
C <sub>iss</sub>	Input Capacitance	VDS=25V,	--	550	--	pF
C <sub>oss</sub>	Output Capacitance	VGS=0V,	--	46	--	pF
C <sub>rss</sub>	Reverse Transfer Capacitance	F=1MHz	--	2.3	--	pF
Q <sub>g</sub>	Total Gate Charge	VDS=480V,	--	10.2	--	nC
Q <sub>gs</sub>	Gate-Source Charge	ID=4A,	--	2.3	--	nC
Q <sub>gd</sub>	Gate-Drain Charge	VGS=10V	--	2.1	--	nC
<b>Switching Characteristics (Note5)</b>						
t <sub>d(on)</sub>	Turn-on Delay Time	VDD=300V,	--	15.5	--	nS
t <sub>r</sub>	Turn-on Rise Time	ID=4A,	--	13	--	nS
t <sub>d(off)</sub>	Turn-off Delay Time	VGS=10V	--	40	--	nS
t <sub>f</sub>	Turn-off Fall Time	RG=25Ω	--	16	--	nS
<b>Source- Drain Diode Characteristics @ T<sub>J</sub> = 25°C (unless otherwise stated)</b>						
V <sub>SD</sub>	Forward on voltage	IS=4A,VGS=0V	--	0.8	1.4	V

Note:

- Limited by T<sub>Jmax</sub>, starting T<sub>J</sub> = 25° C, R<sub>G</sub> = 25Ω, V<sub>D</sub> = 50V, V<sub>GS</sub> = 10V. Part not recommended for use above this value.
- Repetitive Rating: Pulse width limited by maximum junction temperature.
- Surface Mounted on FR4 Board, t ≤ 10 sec.
- Pulse Test: pulse width ≤ 300 us, duty cycle ≤ 2%.
- Guaranteed by design, not subject to production testing.



600V/4A N-Channel Advanced Power MOSFET

Typical Characteristics

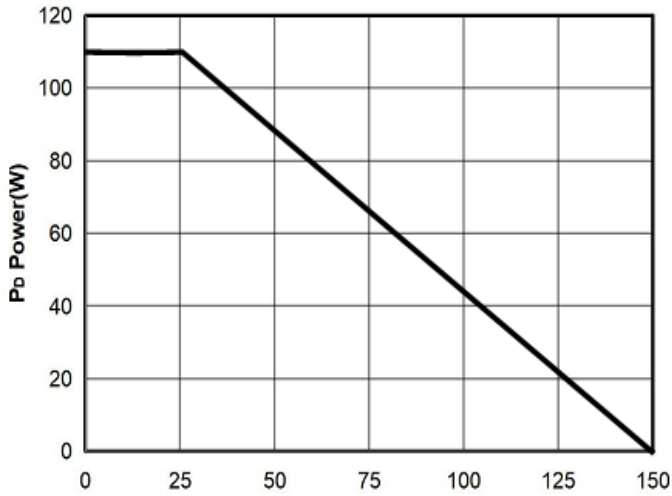

Figure1: Tj Junction Temperature (°C)

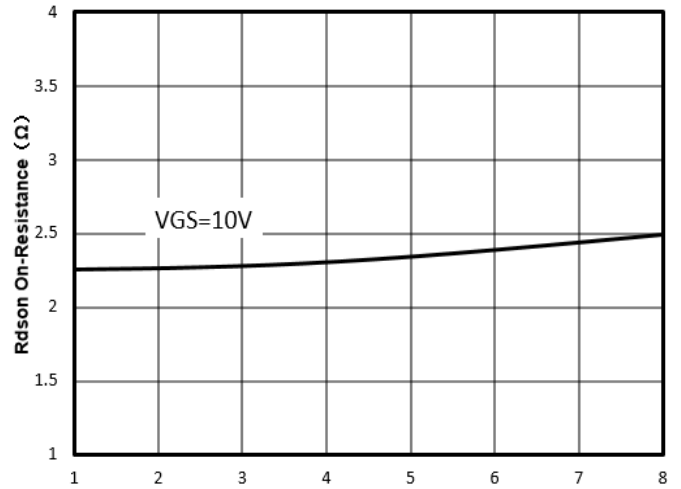

Figure2: Id Drain Current (A)

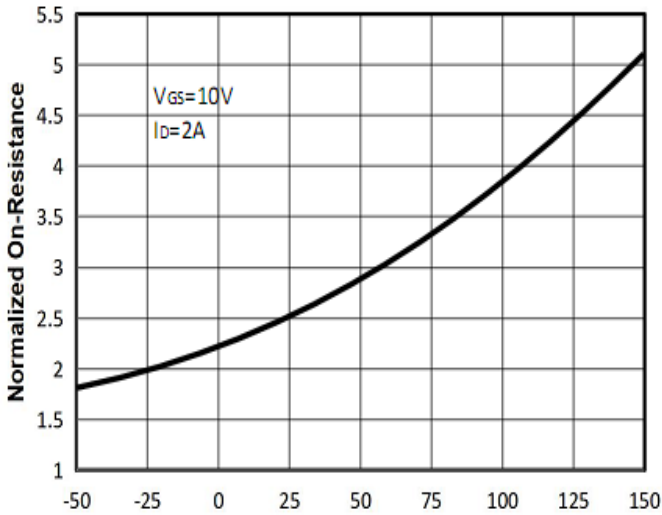

Figure3: Tj Junction Temperature (°C)

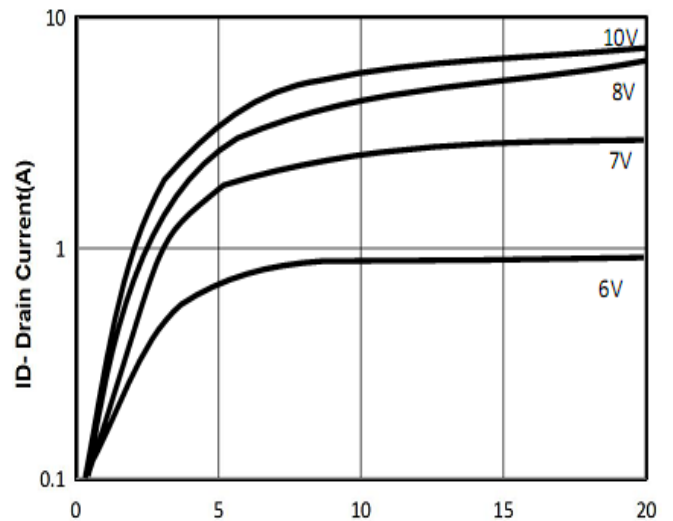

Figure4: Vds Drain-Source Voltage (V)

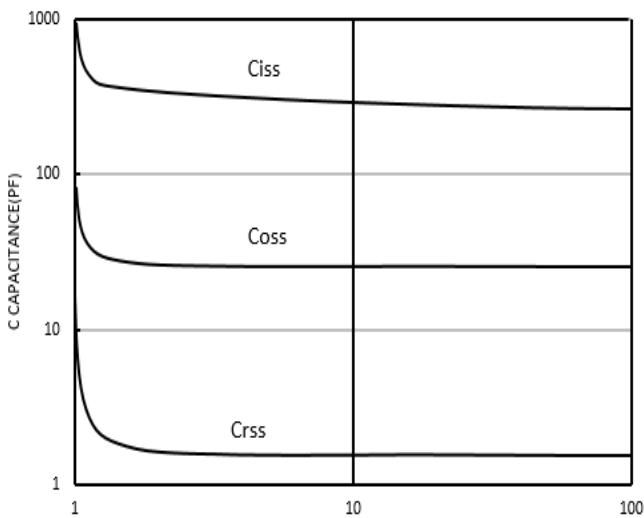

Figure5: Vds Drain-Source Voltage (V)

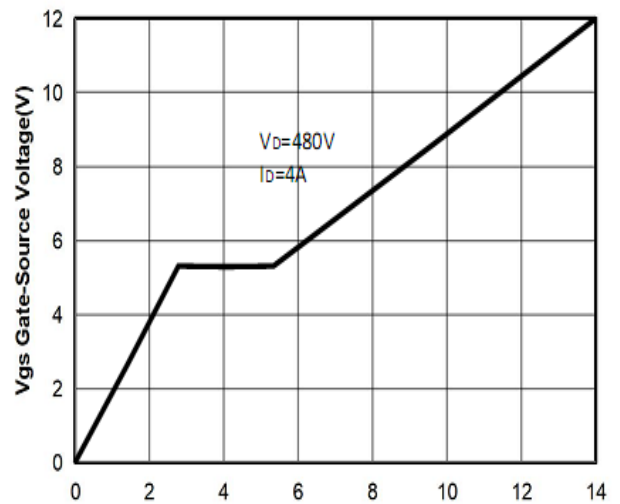

Figure6: Qg Gate Charge (nC)



## 600V/4A N-Channel Advanced Power MOSFET

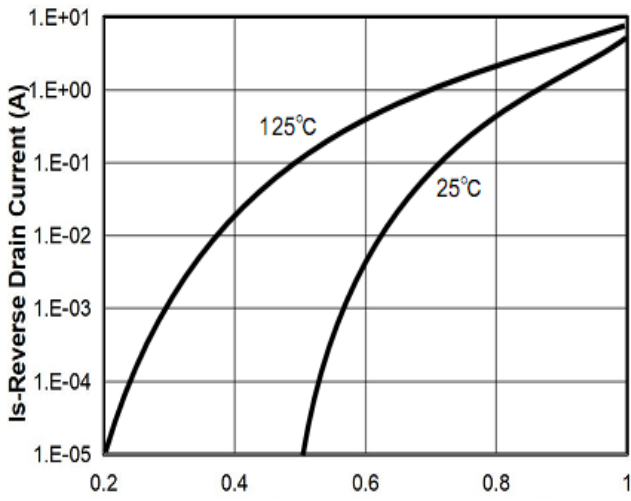

Figure7: Vsd Source-Drain Voltage (V)

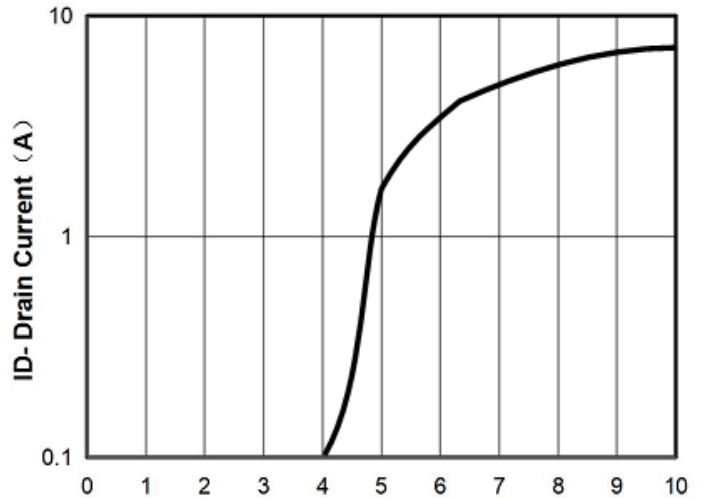

Figure8: Vgs Gate-Source Voltage (V)

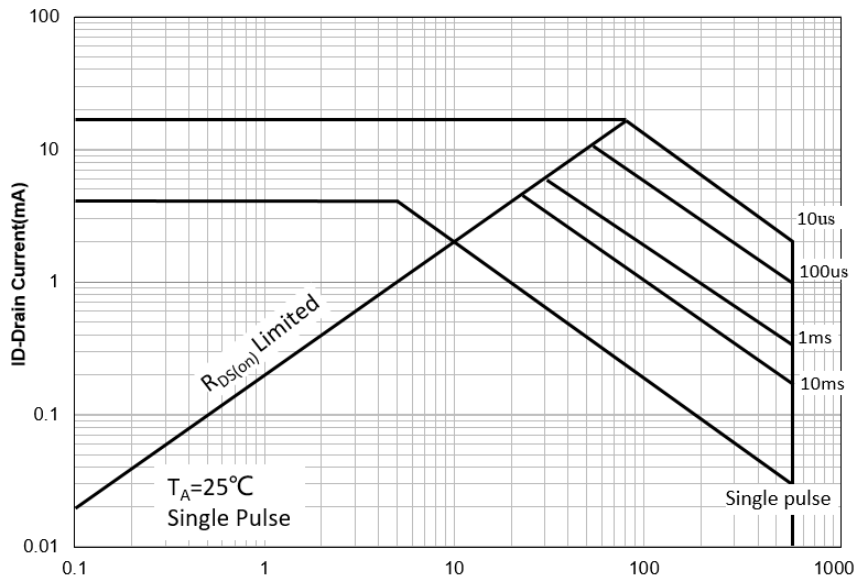

Figure9: VDS Drain -Source Voltage (V)

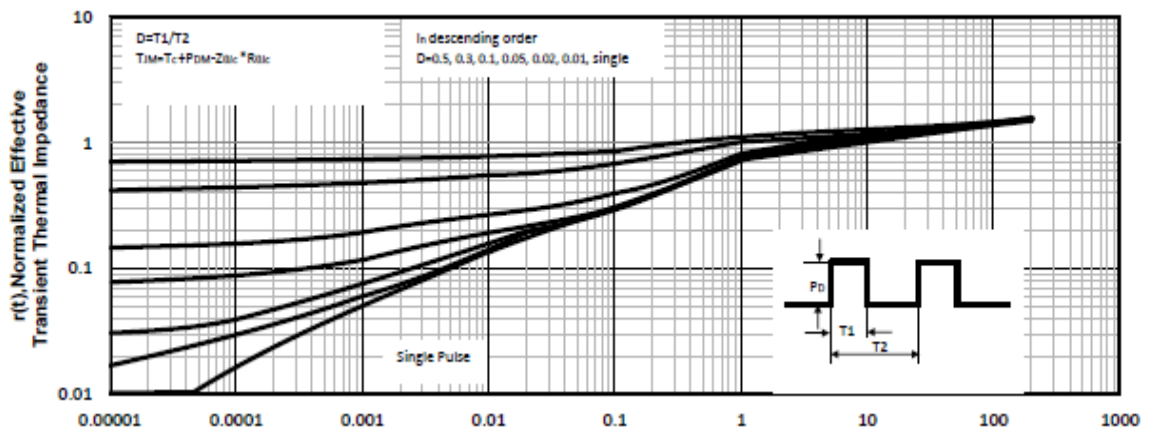

Figure10: Square Wave Pulse Duration (sec)

## 600V/4A N-Channel Advanced Power MOSFET

### Test Circuit and Waveform:

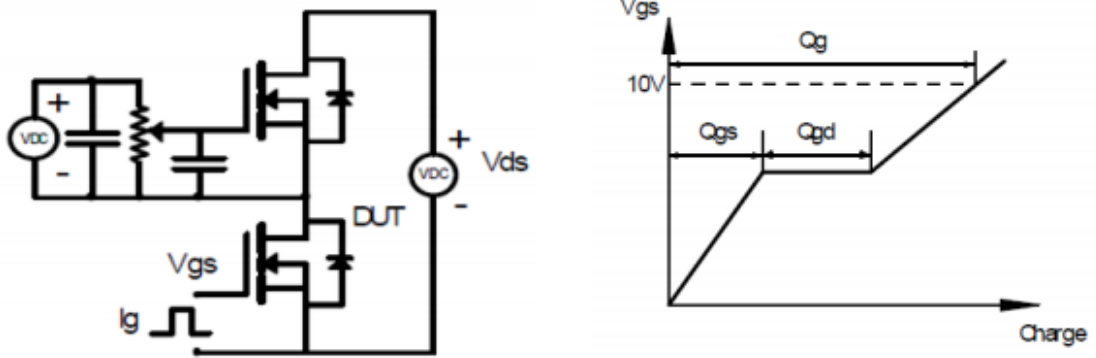

Figure A Gate Charge Test Circuit & Waveforms

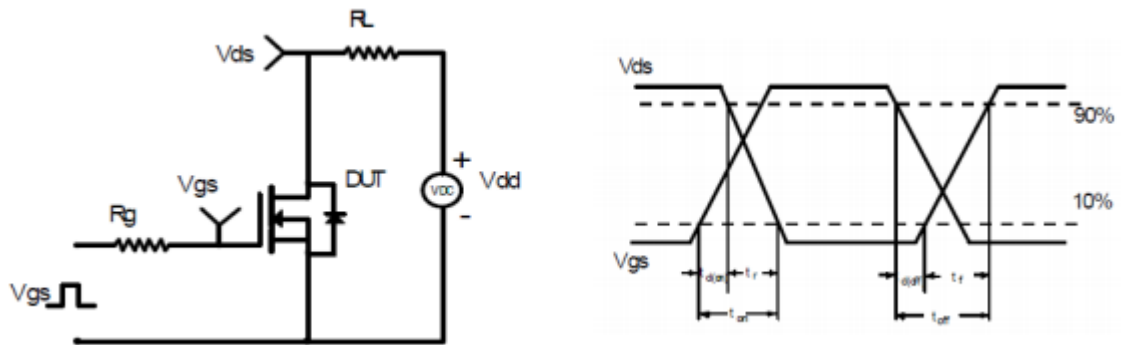

Figure B Switching Test Circuit & Waveforms

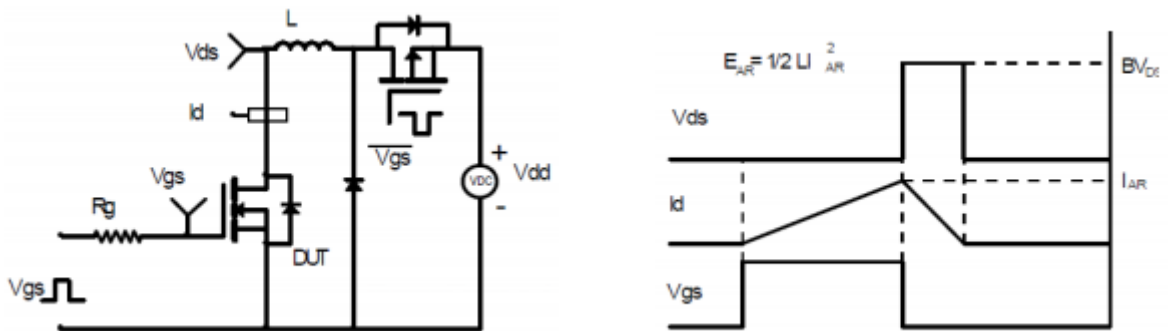
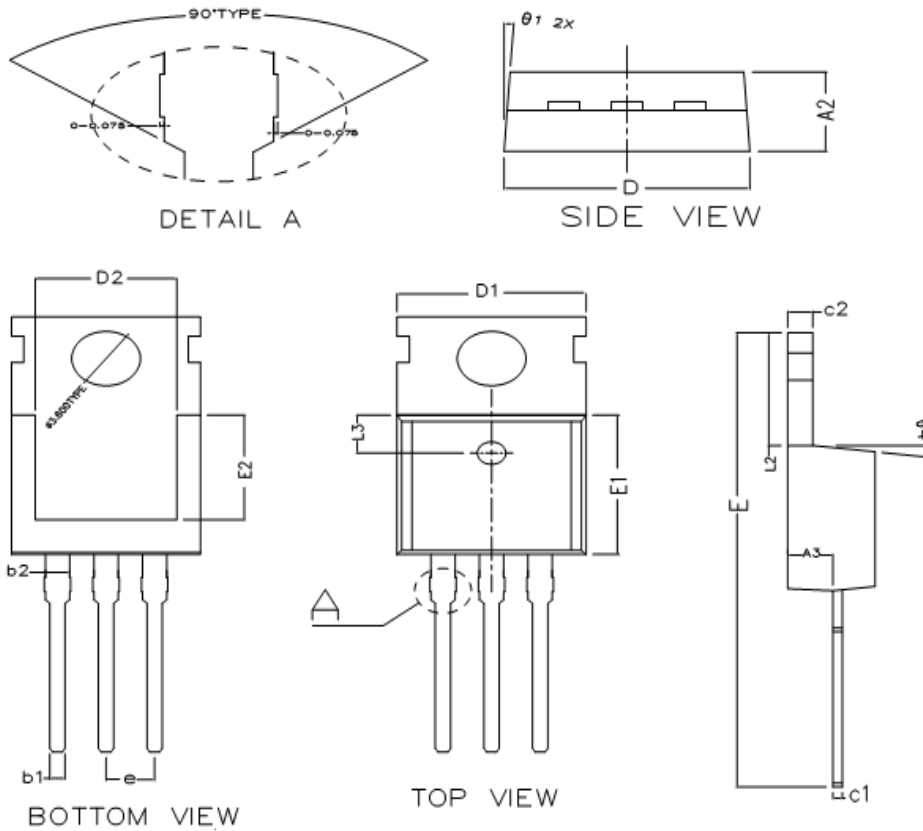

Figure C Unclamped Inductive Switching Circuit & Waveforms



TO-220 Package Outline Dimensions (Units: mm)



COMMON DIMENSIONS (UNITS OF MEASURE IS mm)			
	MIN	NORMAL	MAX
A2	4.470	4.570	4.670
A3	2.300	2.350	2.400
b1	0.750	0.800	0.850
b2	1.27 TYPE		
c1	0.450	0.500	0.550
c2	1.250	1.300	1.380
D	9.900	10.000	10.100
D1	10.000TYPE		
D2	8.000TYPE		
E	28.660	28.860	29.060
E1	9.000	9.100	9.200
E2	7.000TYPE		
e	2.540TYPE		
L2	6.350	6.500	6.650
L3	2.50TYPE		
theta1	3° TYPE		
theta2	3° TYPE		
theta3	7° TYPE		
theta4	7° TYPE		